

# Rubber distributor



**Wolfit**

Wolf International Trading

Office: +51 1 640 9862 | Mobile: +51 943304479  
Trujillo: Juan de Cuéllar R 8 Urb. Miraflores  
Lima: La Perla Mz. G Lt. 8 Las Moreras, Callao  
info@Wolfit.com.pe

 **Bals**

Simply. Well. Connected.

We live in a fast-moving time. It is also frequently necessary to make modifications to power distribution systems. Power distributors used in industrial buildings, production facilities, laboratories, harbour docks, markets, tunnel, road construction sites and many other locations therefore frequently need to be adapted and are subject to very rough treatment.

The MODBOX® is the ideal solution. The new patented MODBOX® rubber distributor series from Bals Elektrotechnik GmbH combines all the demands placed on current distributors up to a maximum protection degree of IP67. As far as impact resistance is concerned, the MODBOX® leaves no wish unfulfilled. The material properties of the MODBOX® are unique: its robustness and resistance to ageing, temperature, oil and acid are unbeatable. The MODBOX® is, of course, also fully insulated, UV-resistant and halogen-free as well as flame-resistant and self-extinguishing.

The truly innovative enclosure design allows existing installations to be adapted quickly. Order separation attachments are provided in the enclosure. This makes it easier to install strong-current and weak-current systems.

An outstanding feature is that MODBOX® units can be easily connected next to each as modules without any modifications needing to be made to the basic installation. The MODBOX® is freely configurable. Four openings in the side of the MODBOX® allow modules to be added in any direction. Another new feature are the yellow connecting and end corners. To further improve safety, the luminous end corners (luminescence time up to 7 hours) are recommended.



Configure your own MODBOX® at [www.bals.com](http://www.bals.com)



User-friendly OTC operating window on MODBOX®-Midi.



Continuous all-round seals provide IP67 protection level



Solid guide rails ensure an extremely high level of dimensional stability, especially at connection between upper and lower part of enclosure

**Corners** (luminous on request) standard end corners in yellow, interchangeable (2 or 4). They allow MODBOX® units to be connected together without problem.

#### Slot and recess

Slot with ring set sealed to achieve the high IP protection level. Wedge-shape rubber teeth for increased stability.

#### Recess in base

Recess provided for order separation if required (strong current and weak current).

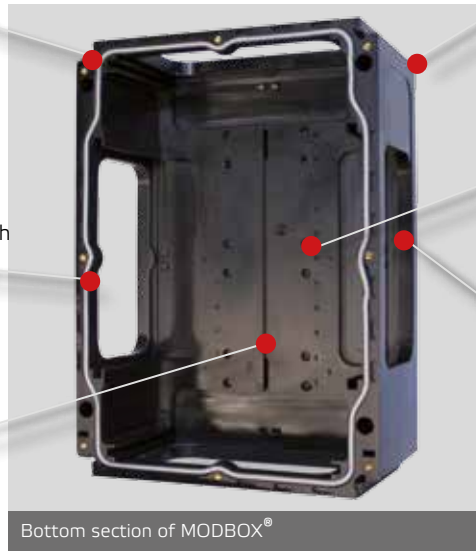

Bottom section of MODBOX®

#### Drill holes

4 drill holes ensure a perfect permanent installation.

#### Cutouts

4 cutouts for attaching the wall mounting anchors.

#### Feedthrough openings

4 openings in the MODBOX® wall facilitate modular expansion of the installation in every direction. The slide-in connector was developed to ensure perfect connection. The frame, inserted if additional modules are added, ensures additional stability. In the standard configuration, the feedthrough openings are sealed off using blanking panels.

# Distributor Quick Search

How to find your distributor.

Example:

You are looking for a distributor with the following components:

Domestic socket x 2







CEE 16A, 230V, 3p x 0

CEE 16A, 400V, 5p x 1

CEE 32A, 400V, 5p x 1

CEE 63A, 400V, 5p x 0

Data socket x 0









 Schuko-type socket 16A,	 CEE - 16A 230V, 3p	 CEE - 16A 400V, 5p	 CEE - 32A 400V, 5p	 CEE - 63A 400V, 5p	 Data socket
2	0	1	0	0	0
2	0	2	0	0	0

Your configuration request yields the following "key number": **202000**

**Your key number must always be six digits long; please fill non-desired products with a zero.**

The key numbers of the most common rubber distributors are listed on pages 4 and 5.

In our example, on page 4 you will find the following distributors with the key number **202000**:

 Schuko-type socket 16A,	 CEE - 16A 230V, 3p	 CEE - 16A 400V, 5p	 CEE - 32A 400V, 5p	 CEE - 63A 400V, 5p	 Data socket	 Fuse RCCB	 Fuse CB	 Fuse Neozed	Order number	Photo: see (page/item)
2	0	1	0	0	0	1 x 40/0,03A, 4p	2 x C, 16A, 1p 1 x C, 16A, 3p		5401886 IP44	6/03
2	0	2	0	0	0	1 x 40/0,03A, 4p	2 x C, 16A, 1p 2 x C, 16A, 3p		5402161 IP67	9/03

All distributors are described again in detail and shown with a photo on the specified page and at the specified item number.











Multiple distributors with different configurations may be available under a single key and can be selected accordingly.

Should you require assistance when making your selection, please contact us or use the distributor quick search feature (Configurator) at [www.bals.com](http://www.bals.com).









Under "Guided Product Search", click **Combinations/distributors**.

On our website, you can also enter the **part number/search** and immediately call up and download the desired distributor with text/dimension drawing and XML.

# Distributor Quick Search

										
Domestic socket	CEE - 16A 230V, 3p	CEE - 16A 400V, 5p	CEE - 32A 400V, 5p	CEE - 63A 400V, 5p	Data socket	Fuse RCCB	Fuse CB	Fuse Neozed	Order number	Photo: see (page/item)
2	0	1	0	0	0	1 x 40/0,03A, 4p	2 x C, 16A, 1p 1 x C, 16A, 3p		5401886 IP44	6/03
2	0	2	0	0	0	1 x 40/0,03A, 4p	2 x C, 16A, 1p 2 x C, 16A, 3p		5402161 IP67	9/03
2	0	1	1	0	0	1 x 63/0,03A, 4p	2 x C, 16A, 1p 1 x C, 16A, 3p 1 x C, 32A, 3p		5402163 IP67	9/05
2	0	1	1	0	0	1 x 40/0,03A, 4p	2 x C, 16A, 1p 1 x C, 16A, 3p 1 x C, 32A, 3p		5402162 IP67	9/04
2	0	1	1	0	0	1 x 40/0,03A, 4p	2 x C, 16A, 1p 1 x C, 16A, 3p		5401892 IP44	6/04
2	0	1	1	0	0	1 x 40/0,03A, 4p	2 x C, 16A, 1p 1 x C, 16A, 3p 1 x C, 32A, 3p		5401302 IP44	8/01
2	0	1	1	0	0	1 x 63/0,03A, 4p	2 x C, 16A, 1p 1 x C, 16A, 3p 1 x C, 32A, 3p		5401274 IP44	8/06
2	0	0	2	0	0	1 x 63/0,03A, 4p	2 x C, 16A, 1p 2 x C, 32A, 3p		5402164 IP67	9/06
2	0	0	2	0	0	1 x 63/0,03A, 4p	2 x C, 16A, 1p 2 x C, 32A, 3p		5402044 IP44	7/06
2	0	1	1	0	1	1 x 40/0,03A, 4p	2 x C, 16A, 1p 1 x C, 16A, 3p 1 x C, 32A, 3p		5402059 IP44	8/07
3	0	0	0	0	0	1 x 40/0,03A, 4p	3 x C, 16A, 1p		5401882 IP44	6/01
3	0	1	0	0	0	1 x 40/0,03A, 4p	3 x C, 16A, 1p 1 x C, 16A, 3p		5402160 IP67	9/02
3	1	1	0	0	0	1 x 40/0,03A, 4p	3 x C, 16A, 1p 1 x C, 16A, 1p 1 x C, 16A, 3p		5402046 IP44	8/02
3	0	2	0	0	0	1 x 40/0,03A, 4p	3 x C, 16A, 1p 2 x C, 16A, 3p		5402166 IP67	9/08
3	0	2	0	0	0		3 x C, 16A, 1p 2 x C, 16A, 3p		5401894 IP44	6/05
3	0	2	0	0	0	1 x 40/0,03A, 4p	3 x C, 16A, 1p 2 x C, 16A, 3p		5401455 IP44	7/01
3	0	1	1	0	0	1 x 63/0,03A, 4p	3 x C, 16A, 1p 1 x C, 16A, 3p 1 x C, 32A, 3p		5402165 IP67	9/07
3	0	1	1	0	0		3 x C, 16A, 1p 1 x C, 16A, 3p 1 x C, 32A, 3p		5401905 IP44	6/06
3	0	1	1	0	0	1 x 40/0,03A, 4p		3 x D01, 1p 1 x D01, 3p	5401668 IP44	7/04
3	0	1	1	0	0			3 x D01, 1p 1 x D01, 3p 1 x D02, 3p	5401662 IP44	7/05
3	0	1	1	0	0	1 x 40/0,03A, 4p	3 x C, 16A, 1p 1 x C, 16A, 3p 1 x C, 32A, 3p		5401343 IP44	7/03
3	0	0	2	0	0	1 x 63/0,03A, 4p	3 x C, 16A, 1p 2 x C, 32A, 3p		5401567 IP44	7/02

# Distributor Quick Search

 Domestic socket	 CEE - 16A 230V, 3p	 CEE - 16A 400V, 5p	 CEE - 32A 400V, 5p	 CEE - 63A 400V, 5p	 Data socket	 Fuse RCCB	 Fuse CB	 Fuse Neozed	Order number	Photo: see (page/item)
3	0	1	1	0	1	1 x 63/0,03A, 4p	3 x C, 16A, 1p 1 x C, 16A, 3p 1 x C, 32A, 3p		5402060 IP44	8/08
4	0	0	0	0	0	1 x 40/0,03A, 4p	4 x C, 16A, 1p		5402159 IP67	9/01
4	0	1	1	0	0		4 x C, 16A, 1p 1 x C, 16A, 3p 1 x C, 32A, 3p		5402047 IP44	8/05
4	0	1	1	0	0	1 x 40/0,03A, 4p	4 x C, 16A, 1p 1 x C, 16A, 3p 1 x C, 32A, 3p		5401801 IP44	8/04
4	0	1	1	0	0	1 x 63/0,03A, 4p	2 x C, 16A, 1p 1 x C, 16A, 3p 1 x C, 32A, 3p		5401453 IP44	8/03
6	0	0	0	0	0	1 x 40/0,03A, 4p	6 x C, 16A, 1p		5401884 IP44	6/02

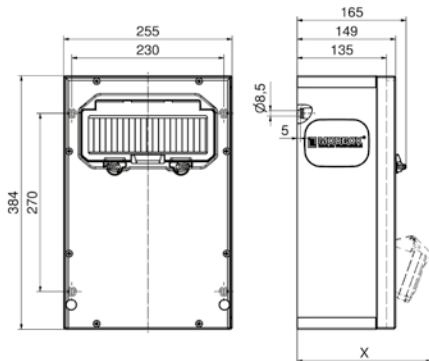

depth x in (mm)		30 MB 218			
with	IP44	IP67	with	IP44	IP67
OTC operating window	165	165	CEE 16A 5p	197	195
domestic socket	152	195	CEE 32A 3p/4p	201	203
CEE 16A 3p	190	190	CEE 32A 5p	203	204
CEE 16A 4p	194	192	CEE 63A 3p/4p/5p	219	221

- Dimension of enclosure: 384 x 255 mm
- Enclosure made of high-quality, impact-resistant solid rubber
- User-friendly OTC operating window
- Modular extension
- Hardness grade of 99 shore
- Resistant to ageing, temperature, oil and acid
- Excellent resistance to chemicals
- Flame-resistant, self-extinguishing
- Top section straight, CEE sockets angled
- All CEE sockets with screwless, maintenance-free QUICK-CONNECT technology
- Black top and bottom section with yellow end corners
- Available in various RAL colours
- Accessories: see page 184

### MODBOX<sup>®</sup>-Midi

Order no. **5401882**

**Components:**  
3 Domestic sockets 16A, 230V ~  
(system F - German earthing System)

**Fuse:**  
3 C-type MCBs 16A, 1p  
1 RCCB 40/0.03A, 4p

**Cable entry at top and bottom:**  
each with 2x M40

**Connection option:**  
for 2 cables up to 5 x 25 mm<sup>2</sup>



Item  
**01**

### MODBOX<sup>®</sup>-Midi

Order no. **5401884**

**Components:**  
6 Domestic sockets 16A, 230V ~  
(system F - German earthing System)

**Fuse:**  
6 C-type MCBs 16A, 1p  
1 RCCB 40/0.03A, 4p

**Cable entry at top and bottom:**  
each with 2x M40

**Connection option:**  
for 2 cables up to 5 x 25 mm<sup>2</sup>



Item  
**02**

### MODBOX<sup>®</sup>-Midi

Order no. **5401886**

**Components:**  
2 Domestic sockets 16A, 230V ~  
(system F - German earthing System)  
1 CEE socket 16A, 400V, 5p

**Fuse:**  
2 C-type MCBs 16A, 1p  
1 C-type MCB 16A, 3p  
1 RCCB 40/0.03A, 4p

**Cable entry at top and bottom:**  
each with 2x M40

**Connection option:**  
for 2 cables up to 5 x 25 mm<sup>2</sup>



Item  
**03**

### MODBOX<sup>®</sup>-Midi

Order no. **5401892**

**Components:**  
2 Domestic sockets 16A, 230V ~  
(system F - German earthing System)  
1 CEE socket 16A, 400V, 5p  
1 CEE socket 32A, 400V, 5p

**Fuse:**  
2 C-type MCBs 16A, 1p  
1 C-type MCB 16A, 3p  
1 RCCB 40/0.03A, 4p

**Cable entry at top and bottom:**  
each with 2x M40

**Connection option:**  
for 2 cables up to 5 x 25 mm<sup>2</sup>



Item  
**04**

### MODBOX<sup>®</sup>-Midi

Order no. **5401894**

**Components:**  
3 Domestic sockets 16A, 230V ~  
(system F - German earthing System)  
2 CEE sockets 16A, 400V, 5p

**Fuse:**  
3 C-type MCBs 16A, 1p  
2 C-type MCBs 16A, 3p

**Cable entry at top and bottom:**  
each with 2x M40

**Connection option:**  
for 2 cables up to 5 x 25 mm<sup>2</sup>



Item  
**05**

### MODBOX<sup>®</sup>-Midi

Order no. **5401905**

**Components:**  
3 Domestic sockets 16A, 230V ~  
(system F - German earthing System)  
1 CEE socket 16A, 400V, 5p  
1 CEE socket 32A, 400V, 5p

**Fuse:**  
3 C-type MCBs 16A, 1p  
1 C-type MCB 16A, 3p  
1 C-type MCB 32A, 3p

**Cable entry at top and bottom:**  
each with 2x M40

**Connection option:**  
for 2 cables up to 5 x 25 mm<sup>2</sup>



Item  
**06**

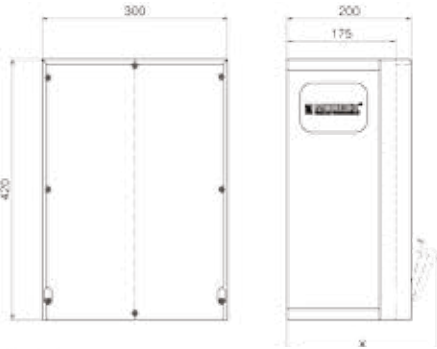

depth x in (mm)

with	IP44	IP67	with	IP44	IP67
domestic socket	192	235	CEE 32A 3p/4p	241	243
CEE 16A 3p	230	230	CEE 32A 5p	243	244
CEE 16A 4p	234	232	CEE 63A 3p/4p/5p	259	261
CEE 16A 5p	237	235			

13MB109

- Dimension of enclosure: 420 x 300 mm
- Ready wired for installation
- Enclosure made of high-quality, impact-resistant solid rubber
- Modular extension
- Hardness grade of 99 shore
- Resistant to ageing, temperature, oil and acid
- Excellent resistance to chemicals
- Flame-resistant, self-extinguishing
- Top section straight, CEE sockets angled
- All CEE sockets with screwless, maintenance-free QUICK-CONNECT technology
- Black top and bottom section with yellow end corners
- Available in various RAL colours
- Accessories: see page 184



Item  
01

Order no. **5401455**

**Components:**

3 Domestic sockets 16A, 230V ~  
(system F - German earthing System)  
2 CEE sockets 16A, 400V, 5p

**Fuse:**

3 C-type MCBs 16A, 1p  
2 C-type MCBs 16A, 3p  
1 RCCB 40/0.03A, 4p

**Cable entry at top and bottom:**

each with 2x M40

**Connection option:**

for 2 cables up to 5 x 25 mm<sup>2</sup>



Item  
02

Order no. **5401567**

**Components:**

3 Domestic sockets 16A, 230V ~  
(system F - German earthing System)  
2 CEE sockets 32A, 400V, 5p

**Fuse:**

3 C-type MCBs 16A, 1p  
2 C-type MCBs 32A, 3p  
1 RCCB 63/0.03A, 4p

**Cable entry at top and bottom:**

each with 2x M40

**Connection option:**

for 2 cables up to 5 x 25 mm<sup>2</sup>



Item  
03

Order no. **5401343**

**Components:**

3 Domestic sockets 16A, 230V ~  
(system F - German earthing System)  
1 CEE socket 16A, 400V, 5p  
1 CEE socket 32A, 400V, 5p

**Fuse:**

3 C-type MCBs 16A, 1p  
1 C-type MCB 16A, 3p  
1 C-type MCB 32A, 3p  
1 RCCB 40/0.03A, 4p

**Cable entry at top and bottom:**

each with 2x M40

**Connection option:**

for 2 cables up to 5 x 16 mm<sup>2</sup>



Item  
04

Order no. **5401668**

**Components:**

3 Domestic sockets 16A, 230V ~  
(system F - German earthing System)  
1 CEE socket 16A, 400V, 5p  
1 CEE socket 32A, 400V, 5p

**Fuse:**

3 Neozed D01, 1p  
1 Neozed D01, 3p  
1 RCCB 40/0.03A, 4p

**Cable entry at top and bottom:**

each with 2x M40

**Connection option:**

for 2 cables up to 5 x 25 mm<sup>2</sup>



Item  
05

Order no. **5401662**

**Components:**

3 Domestic sockets 16A, 230V ~  
(system F - German earthing System)  
1 CEE socket 16A, 400V, 5p  
1 CEE socket 32A, 400V, 5p

**Fuse:**

3 Neozed D01, 1p  
1 Neozed D01, 3p  
1 Neozed D02, 3p

**Cable entry at top and bottom:**

each with 2x M40

**Connection option:**

for 2 cables up to 5 x 25 mm<sup>2</sup>



Item  
06

Order no. **5402044**

**Components:**

2 Domestic sockets 16A, 230V ~  
(system F - German earthing System)  
2 CEE sockets 32A, 400V, 5p

**Fuse:**

2 C-type MCBs 16A, 1p  
2 C-type MCBs 32A, 3p  
1 RCCB 630.03A, 4p

**Cable entry at top and bottom:**

each with 2x M40

**Connection option:**

for 2 cables up to 5 x 25 mm<sup>2</sup>



Order no. **5401302**



**Components:**  
2 Domestic sockets 16A, 230V ~  
(system F - German earthing System)  
1 CEE socket 16A, 400V, 5p  
1 CEE socket 32A, 400V, 5p

**Fuse:**  
2 C-type MCBs 16A, 1p  
1 C-type MCB 16A, 3p  
1 C-type MCB 32A, 3p  
1 RCCB 40/0.03A, 4p

**Cable entry at top and bottom:**  
each with 2x M40

**Connection option:**  
for 2 cables up to 5 x 25 mm<sup>2</sup>

Item  
**01**



Order no. **5402046**



**Components:**  
3 Domestic sockets 16A, 230V ~  
(system F - German earthing System)  
1 CEE socket 16A, 230V, 3p  
1 CEE socket 16A, 400V, 5p

**Fuse:**  
3 C-type MCBs 16A, 1p  
1 C-type MCB 16A, 1p  
1 C-type MCB 16A, 3p  
1 RCCB 40/0.03A, 4p

**Cable entry at top and bottom:**  
each with 2x M40

**Connection option:**  
for 2 cables up to 5 x 25 mm<sup>2</sup>

Item  
**02**



Order no. **5401453**



**Components:**  
4 Domestic sockets 16A, 230V ~  
(system F - German earthing System)  
1 CEE socket 16A, 400V, 5p  
1 CEE socket 32A, 400V, 5p

**Fuse:**  
2 C-type MCBs 16A, 1p  
1 C-type MCB 16A, 3p  
1 C-type MCB 32A, 3p  
1 RCCB 63/0.03A, 4p

**Cable entry at top and bottom:**  
each with 2x M40

**Connection option:**  
for 2 cables up to 5 x 25 mm<sup>2</sup>

Item  
**03**



Order no. **5401801**



**Components:**  
4 Domestic sockets 16A, 230V ~  
(system F - German earthing System)  
1 CEE socket 16A, 400V, 5p  
1 CEE socket 32A, 400V, 5p

**Fuse:**  
4 C-type MCBs 16A, 1p  
1 C-type MCB 16A, 3p  
1 C-type MCB 32A, 3p  
1 RCCB 40/0.03A, 4p

**Cable entry at top and bottom:**  
each with 2x M40

**Connection option:**  
for 2 cables up to 5 x 25 mm<sup>2</sup>

Item  
**04**



Order no. **5402047**



**Components:**  
4 Domestic sockets 16A, 230V ~  
(system F - German earthing System)  
1 CEE socket 16A, 400V, 5p  
1 CEE socket 32A, 400V, 5p

**Fuse:**  
4 C-type MCBs 16A, 1p  
1 C-type MCB 16A, 3p  
1 C-type MCB 32A, 3p

**Cable entry at top and bottom:**  
each with 2x M40

**Connection option:**  
for 2 cables up to 5 x 25 mm<sup>2</sup>

Item  
**05**



Order no. **5401274**



**Components:**  
2 Domestic sockets 16A, 230V ~  
(system F - German earthing System)  
1 CEE socket 16A, 400V, 5p  
1 CEE socket 32A, 400V, 5p

**Fuse:**  
2 C-type MCBs 16A, 1p  
1 C-type MCB 16A, 3p  
1 C-type MCB 32A, 3p  
1 RCCB 63/0.03A, 4p

**Cable entry at top and bottom:**  
each with 2x M40

**Connection option:**  
for 2 cables up to 5 x 25 mm<sup>2</sup>

Item  
**06**



Order no. **5402059**



**Components:**  
2 Domestic sockets 16A, 230V ~  
(system F - German earthing System)  
1 CEE socket 16A, 400V, 5p  
1 CEE socket 32A, 400V, 5p  
1 double data socket RJ45 CAT6 IP55

**Fuse:**  
2 C-type MCBs 16A, 1p  
1 C-type MCB 16A, 3p  
1 C-type MCB 32A, 3p  
1 RCCB 40/0.03A, 4p

**Cable entry at top and bottom:**  
each with 2x M20, 2x M40

**Connection option:**  
for 2 cables up to 5 x 25 mm<sup>2</sup>

Item  
**07**



Order no. **5402060**



**Components:**  
3 Domestic sockets 16A, 230V ~  
(system F - German earthing System)  
1 CEE socket 16A, 400V, 5p  
1 CEE socket 32A, 400V, 5p  
1 double data socket RJ45 CAT6 IP55

**Fuse:**  
3 C-type MCBs 16A, 1p  
1 C-type MCB 16A, 3p  
1 C-type MCB 32A, 3p  
1 RCCB 63/0.03A, 4p

**Cable entry at top and bottom:**  
each with 2x M20, 2x M40

**Connection option:**  
for 2 cables up to 5 x 16 mm<sup>2</sup>

Item  
**08**





Order no. **5402159**

**Components:**

4 Domestic sockets 16A, 230V ~  
(system F - German earthing System)

**Fuse:**

4 C-type MCBs 16A, 1p  
1 RCCB 40/0.03A, 4p

**Cable entry at bottom:**

1x M12, 2x M40

**Connection option:**

for 2 cables up to 5 x 25 mm<sup>2</sup>

Item  
01



Order no. **5402160**

**Components:**

3 Domestic sockets 16A, 230V ~  
(system F - German earthing System)  
1 CEE socket 16A, 400V, 5p

**Fuse:**

3 C-type MCBs 16A, 1p  
1 C-type MCB 16A, 3p  
1 RCCB 40/0.03A, 4p

**Cable entry at bottom:**

1x M12, 2x M40

**Connection option:**

for 2 cables up to 5 x 25 mm<sup>2</sup>

Item  
02



Order no. **5402161**

**Components:**

2 Domestic sockets 16A, 230V ~  
(system F - German earthing System)  
2 CEE sockets 16A, 400V, 5p

**Fuse:**

2 C-type MCBs 16A, 1p  
2 C-type MCBs 16A, 3p  
1 RCCB 40/0.03A, 4p

**Cable entry at bottom:**

1x M12, 2x M40

**Connection option:**

for 2 cables up to 5 x 25 mm<sup>2</sup>

Item  
03



Order no. **5402162**

**Components:**

2 Domestic sockets 16A, 230V ~  
(system F - German earthing System)  
1 CEE socket 16A, 400V, 5p  
1 CEE socket 32A, 400V, 5p

**Fuse:**

2 C-type MCBs 16A, 1p  
1 C-type MCB 16A, 3p  
1 C-type MCB 32A, 3p  
1 RCCB 40/0.03A, 4p

**Cable entry at bottom:**

1x M12, 2x M40

**Connection option:**

for 2 cables up to 5 x 25 mm<sup>2</sup>

Item  
04



Order no. **5402163**

**Components:**

2 Domestic sockets 16A, 230V ~  
(system F - German earthing System)  
1 CEE socket 16A, 400V, 5p  
1 CEE socket 32A, 400V, 5p

**Fuse:**

2 C-type MCBs 16A, 1p  
1 C-type MCB 16A, 3p  
1 C-type MCB 32A, 3p  
1 RCCB 63/0.03A, 4p

**Cable entry at bottom:**

1x M12, 2x M40

**Connection option:**

for 2 cables up to 5 x 25 mm<sup>2</sup>

Item  
05



Order no. **5402164**

**Components:**

2 Domestic sockets 16A, 230V ~  
(system F - German earthing System)  
2 CEE sockets 32A, 400V, 5p

**Fuse:**

2 C-type MCBs 16A, 1p  
2 C-type MCBs 32A, 3p  
1 RCCB 63/0.03A, 4p

**Cable entry at bottom:**

1x M12, 2x M40

**Connection option:**

for 2 cables up to 5 x 25 mm<sup>2</sup>

Item  
06



Order no. **5402165**

**Components:**

3 Domestic sockets 16A, 230V ~  
(system F - German earthing System)  
1 CEE socket 16A, 400V, 5p  
1 CEE socket 32A, 400V, 5p

**Fuse:**

3 C-type MCBs 16A, 1p  
1 C-type MCB 16A, 3p  
1 C-type MCB 32A, 3p  
1 RCCB 63/0.03A, 4p

**Cable entry at bottom:**

1x M12, 2x M40

**Connection option:**

for 2 cables up to 5 x 25 mm<sup>2</sup>

Item  
07



Order no. **5402166**

**Components:**

3 Domestic sockets 16A, 230V ~  
(system F - German earthing System)  
2 CEE sockets 16A, 400V, 5p

**Fuse:**

3 C-type MCBs 16A, 1p  
2 C-type MCBs 16A, 3p  
1 RCCB 40/0.03A, 4p

**Cable entry at bottom:**

1x M12, 2x M40

**Connection option:**

for 2 cables up to 5 x 25 mm<sup>2</sup>

Item  
08

# Surface mounting combinations

## Solid-rubber Enclosure, Surface Mounting

- Ready wired for installation

- Protection degree IP44

- All distributors on this page with domestic sockets, German earthing

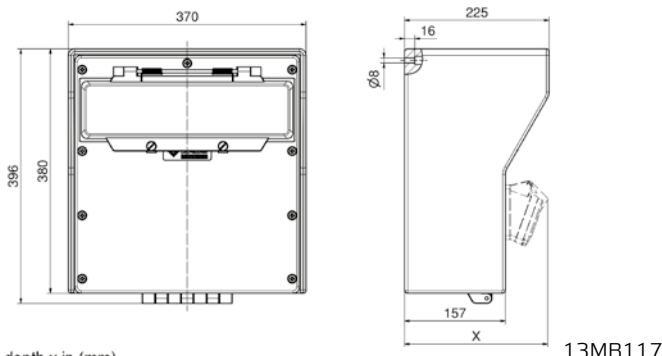

13MB117

depth x in (mm)

with	IP44	IP67
OTC operating window	172	215
schuko-type	210	210
CEE 16A 3p	214	212
CEE 16A 4p	217	215

with	IP44	IP67
CEE 32A 3p/4p	221	223
CEE 32A 5p	223	224
CEE 63A 3p/4p/5p	239	241

- Dimension of enclosure: 380 x 370 mm
- Enclosure made of high-quality, impact-resistant solid rubber
- Space for up to 18 modules under operating window
- Hardness grade of 97 shore
- Hinged lid
- Resistant to ageing, temperature, oil and acid
- Flame-resistant, self-extinguishing
- All CEE sockets with screwless, maintenance-free QUICK-CONNECT technology



Order no. **5402049**

**Components:**  
4 Domestic sockets 16A, 230V ~ (system F - German earthing System)  
2 CEE sockets 16A, 400V, 5p  
1 CEE socket 32A, 400V, 5p

**Fuse:**  
4 C-type MCBs 16A, 1p  
2 C-type MCBs 16A, 3p  
1 C-type MCB 32A, 3p  
1 RCCB 63/0.03A, 4p

**Cable entry at top and bottom:**  
each with 2x M40

**Connection option:**  
for 2 cables up to 5 x 25 mm<sup>2</sup>

Item **01**



Order no. **5402050**

**Components:**  
4 Domestic sockets 16A, 230V ~ (system F - German earthing System)  
2 CEE sockets 16A, 400V, 5p  
1 CEE socket 32A, 400V, 5p

**Fuse:**  
4 C-type MCBs 16A, 1p  
2 C-type MCBs 16A, 3p  
1 C-type MCB 32A, 3p

**Cable entry at top and bottom:**  
each with 2x M40

**Connection option:**  
for 2 cables up to 5 x 25 mm<sup>2</sup>

Item **02**



Order no. **5402051**

**Components:**  
2 Domestic sockets 16A, 230V ~ (system F - German earthing System)  
1 CEE socket 16A, 400V, 5p  
1 CEE socket 32A, 400V, 5p  
1 CEE socket 63A, 400V, 5p

**Fuse:**  
2 C-type MCBs 16A, 1p  
1 C-type MCB 16A, 3p  
1 C-type MCB 32A, 3p  
1 Neozed D02, 3p  
1 RCCB 63/0.03A, 4p

**Cable entry at top and bottom:**  
each with 2x M40

**Connection option:**  
for 2 cables up to 5 x 25 mm<sup>2</sup>

Item **03**



Order no. **5402052**

**Components:**  
4 Domestic sockets 16A, 230V ~ (system F - German earthing System)  
1 CEE socket 16A, 400V, 5p  
1 CEE socket 32A, 400V, 5p  
1 CEE socket 63A, 400V, 5p

**Fuse:**  
4 C-type MCBs 16A, 1p  
1 C-type MCB 16A, 3p  
1 C-type MCB 32A, 3p  
1 RCCB 63/0.03A, 4p

**Cable entry at top and bottom:**  
each with 2x M40

**Connection option:**  
for 2 cables up to 5 x 25 mm<sup>2</sup>

Item **03**



Order no. **5402053**

**Components:**  
4 Domestic sockets 16A, 230V ~ (system F - German earthing System)  
1 CEE socket 16A, 400V, 5p  
1 CEE socket 32A, 400V, 5p  
1 CEE socket 63A, 400V, 5p

**Fuse:**  
4 C-type MCBs 16A, 1p  
1 C-type MCB 16A, 3p  
1 C-type MCB 32A, 3p

**Cable entry at top and bottom:**  
each with 2x M40

**Connection option:**  
for 2 cables up to 5 x 25 mm<sup>2</sup>

Item **04**



Order no. **5402054**

**Components:**  
2 Domestic sockets 16A, 230V ~ (system F - German earthing System)  
1 CEE socket 16A, 400V, 5p  
1 CEE socket 32A, 400V, 5p  
1 CEE socket 63A, 400V, 5p

**Fuse:**  
2 Neozed D01, 1p  
1 Neozed D01, 3p  
2 Neozed D02, 3p

**Cable entry at top and bottom:**  
each with 2x M50

**Connection option:**  
for 2 cables up to 5 x 25 mm<sup>2</sup>

Item **05**

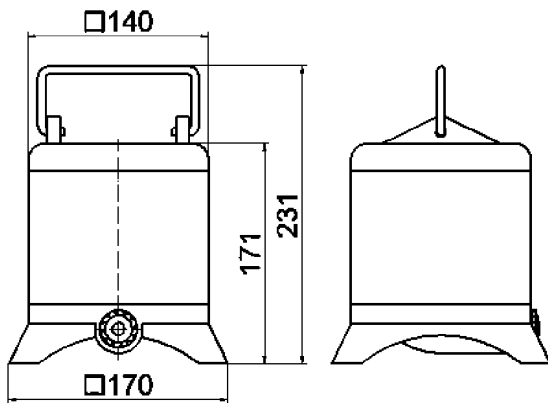

13MB052

- Dimension of enclosure: 140 x 140 mm
- Enclosure made of high-quality, impact-resistant solid rubber
- Small, compact design
- Top and bottom in signal yellow
- Handle made of stainless steel



Item  
01

Order no. **57275**

**Components:**

2 Domestic sockets 16A, 230V ~  
(system F - German earthing System)  
1 CEE socket 16A, 400V, 5p

**Fuse:**

1 RCCB 25/0.03A, 2p

**Cable entry/inlet:**

CEE plug 16A, 400V, 5p with  
lead 2 m H07RN-F5G1,5



Item  
02

Order no. **57148**

**Components:**

2 Domestic sockets 16A, 230V ~  
(system F - German earthing System)  
2 CEE sockets 16A, 400V, 5p

**Cable entry/inlet:**

CEE plug 16A, 400V, 5p with  
lead 2 m H07RN-F5G2,5



Item  
03

Order no. **57623**

**Components:**

4 Domestic sockets 16A, 230V ~  
(system F - German earthing System)

**Cable entry/inlet:**

Domestic plug 16A, 230V, 3p  
4 m cable H07RN-F3G2,5



Item  
04

Order no. **57996**

**Components:**

2 Domestic sockets 16A, 230V ~  
(system F - German earthing System)  
1 CEE socket 16A, 400V, 5p  
1 rotary field measuring device

**Fuse:**

1 RCCB 40/0.03A, 4p

**Cable entry/inlet:**

CEE phase inverter 16A, 400V, 5p with  
lead 2 m H07RN-F5G2,5



Item  
05

Order no. **57255**

**Components:**

2 Domestic sockets 16A, 230V ~  
(system F - German earthing System)  
1 CEE socket 16A, 400V, 5p

**Fuse:**

1 RCCB 40/0.03A, 4p

**Cable entry/inlet:**

CEE plug 16A, 400V, 5p with  
lead 2 m H07RN-F5G2,5



Item  
06

Order no. **57143**

**Components:**

3 Domestic sockets 16A, 230V ~  
(system F - German earthing System)  
1 CEE socket 16A, 400V, 5p

**Cable entry/inlet:**

CEE plug 16A, 400V, 5p with  
lead 2 m H07RN-F5G2,5

# Block distributors

## Solid-rubber Enclosure, portable

- Ready wired for installation
- Protection degree IP44

- All distributors on this page with domestic sockets, German earthing

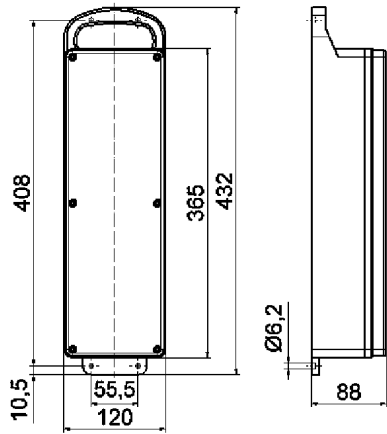

13MB007

- Dimension of enclosure: 365 x 120 mm
- Enclosure made of high-quality, impact-resistant solid rubber
- Ideally suited to tough, harsh and difficult conditions
- Convenient and compact design
- With moulded carrying handle

Item  
01

Order no. **530179**

**Components:**  
 1 Domestic socket 16A, 230V ~  
 (system F - German earthing System)  
 1 CEE socket 16A, 400V, 5p  
 1 CEE socket 32A, 400V, 5p

**Fuse:**  
 1 C-type MCB 16A, 1p  
 1 C-type MCB 16A, 3p

**Cable entry/inlet:**  
 CEE plug 32A, 400V, 5p with  
 lead 1.8 m H07RN-F5G4

Item  
02

Order no. **5310**

**Components:**  
 3 CEE sockets 16A, 400V, 5p

**Cable entry/inlet:**  
 CEE plug 16A, 400V, 5p with  
 lead 1.8 m H07RN-F5G2,5

Item  
03

Order no. **53141**

**Components:**  
 4 Domestic sockets 16A, 230V ~  
 (system F - German earthing System)

**Fuse:**  
 1 RCCB 25/0.03A, 2p

**Cable entry/inlet:**  
 Domestic plug 16A, 230V, 3p with 2 m  
 lead H07RN-F3G2,5

Item  
04

Order no. **53525**

**Components:**  
 3 CEE sockets 32A, 400V, 5p

**Cable entry/inlet:**  
 CEE plug 32A, 400V, 5p with  
 lead 2 m H07RN-F5G4

Item  
05

Order no. **53420**

**Components:**  
 2 CEE sockets 16A, 400V, 5p

**Fuse:**  
 2 C-type MCBs 16A, 3p

**Cable entry/inlet:**  
 CEE plug 32A, 400V, 5p with  
 lead 2 m H07RN-F5G6

Item  
06

Order no. **53290**

**Components:**  
 4 Domestic sockets 16A, 230V ~  
 (system F - German earthing System)  
 1 CEE socket 16A, 400V, 5p

**Cable entry/inlet:**  
 CEE plug 16A, 400V, 5p with  
 lead 2 m H07RN-F5G2,5

# Block distributors

## Solid-rubber Enclosure, portable

- Ready wired for installation
- Protection degree IP44

- All distributors on this page with domestic sockets, German earthing



Item 01

Order no. **530003**

**Components:**  
2 Domestic sockets 16A, 230V ~  
(system F - German earthing System)  
1 CEE socket 16A, 400V, 5p

**Fuse:**  
2 C-type MCBs 16A, 1p  
1 RCCB 40/0.03A, 4p

**Cable entry/inlet:**  
CEE plug 16A, 400V, 5p with  
lead 2 m H07RN-F5G2,5



Item 02

Order no. **530**

**Components:**  
2 Domestic sockets 16A, 230V ~  
(system F - German earthing System)  
1 CEE socket 16A, 400V, 5p

**Fuse:**  
1 RCCB 40/0.03A, 4p

**Cable entry/inlet:**  
CEE plug 16A, 400V, 5p with  
lead 1.8 m H07RN-F5G2,5



Item 03

Order no. **5311**

**Components:**  
2 Domestic sockets 16A, 230V ~  
(system F - German earthing System)  
1 CEE socket 16A, 400V, 5p

**Cable entry/inlet:**  
CEE plug 16A, 400V, 5p with  
lead 1.8 m H07RN-F5G2,5



Item 04

Order no. **5350**

**Components:**  
3 Domestic sockets 16A, 230V ~  
(system F - German earthing System)

**Cable entry/inlet:**  
Domestic plug 16A, 230V, 3p  
with 2 m cable H07RN-F3G2,5



Item 05

Order no. **53247**

**Components:**  
6 Domestic sockets 16A, 230V ~  
(system F - German earthing System)

**Cable entry/inlet:**  
CEE plug 16A, 400V, 5p with  
lead 2 m H07RN-F5G2,5



Item 06

Order no. **53213**

**Components:**  
4 Domestic sockets 16A, 230V ~  
(system F - German earthing System)

**Fuse:**  
1 RCCB 40/0.03A, 4p

**Cable entry/inlet:**  
CEE plug 16A, 400V, 5p with  
lead 2 m H07RN-F5G2,5



Item 07

Order no. **5321**

**Components:**  
3 Domestic sockets 16A, 230V ~  
(system F - German earthing System)

**Fuse:**  
1 RCCB 40/0.03A, 4p

**Cable entry/inlet:**  
CEE plug 16A, 400V, 5p with  
lead 2 m H07RN-F5G2,5



Item 08

Order no. **530321**

**Components:**  
3 CEE sockets 16A, 400V, 5p

**Fuse:**  
1 RCCB 40/0.03A, 4p

**Cable entry/inlet:**  
CEE plug 16A, 400V, 5p with  
lead 2 m H07RN-F5G2,5

# Block distributors

## Solid-rubber Enclosure, portable

- Ready wired for installation
- Protection degree IP44

- All distributors on this page with domestic sockets, German earthing

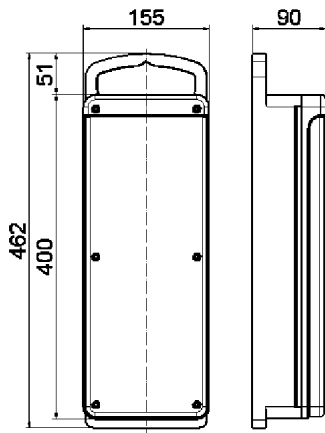

13MB054

- Dimension of enclosure: 400 x 150 mm
- Enclosure made of high-quality, impact-resistant solid rubber
- Ideally suited to tough, harsh and difficult conditions
- Convenient and compact design
- With moulded carrying handle



Item  
01

Order no. **53909**

**Components:**  
6 Domestic sockets 16A, 230V ~  
(system F - German earthing System)

**Fuse:**  
3 C-type MCBs 16A, 1p  
1 RCCB 40/0.03A, 4p

**Cable entry/inlet:**  
CEE plug 32A, 400V, 5p with  
lead 2 m H07RN-F5G4



Item  
02

Order no. **53681**

**Components:**  
6 Domestic sockets 16A, 230V ~  
(system F - German earthing System)  
1 CEE socket 16A, 400V, 5p

**Fuse:**  
1 RCCB 40/0.03A, 4p

**Cable entry/inlet:**  
CEE plug 16A, 400V, 5p with  
lead 2 m H07RN-F5G2,5



Item  
03

Order no. **53679**

**Components:**  
12 Domestic sockets 16A, 230V ~  
(system F - German earthing System)

**Cable entry/inlet:**  
CEE plug 16A, 400V, 5p with  
lead 2 m H07RN-F5G2,5



Item  
04

Order no. **53090**

**Components:**  
6 Domestic sockets 16A, 230V ~  
(system F - German earthing System)  
1 CEE socket 32A, 400V, 5p

**Fuse:**  
3 C-type MCBs 16A, 1p  
1 RCCB 40/0.03A, 4p

**Cable entry/inlet:**  
CEE plug 32A, 400V, 5p with  
lead 2 m H07RN-F5G4



Item  
05

Order no. **530425**

**Components:**  
6 Domestic sockets 16A, 230V ~  
(system F - German earthing System)  
1 CEE socket 16A, 400V, 5p

**Fuse:**  
3 C-type MCBs 16A, 1p  
1 RCCB 40/0.03A, 4p

**Cable entry/inlet:**  
CEE plug 16A, 400V, 5p with  
lead 2 m H07RN-F5G2,5



Item  
06

Order no. **530426**

**Components:**  
2 Domestic sockets 16A, 230V ~  
(system F - German earthing System)  
1 CEE socket 16A, 400V, 5p  
1 CEE socket 32A, 400V, 5p

**Fuse:**  
2 C-type MCBs 16A, 1p  
1 C-type MCB 16A, 3p

**Cable entry/inlet:**  
CEE plug 32A, 400V, 5p with  
lead 2 m H07RN-F5G4

# Floor-standing distributors

# Solid-rubber Enclosure, portable

- Ready wired for installation
- Protection degree IP44

- All distributors on this page with domestic sockets, German earthing

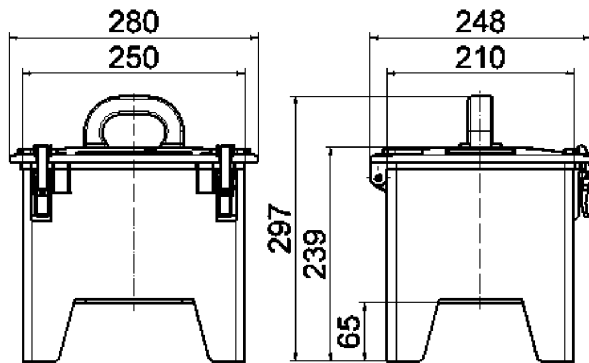

13MB043

- Dimension of enclosure: 250 x 210 mm
- Enclosure made of high-quality, impact-resistant solid rubber
- Ideally suited to tough, harsh and difficult conditions
- Robust solid-rubber handle with hook for cable
- Lockable stainless-steel quick-release fasteners
- Hinged lid, user-friendly access to protective equipment
- Stackable, foot attachment on enclosure cover
- High rubber feet to avoid dirt at floor level



Item  
01

Order no. **5226**

**Components:**

- 4 Domestic sockets 16A, 230V ~ (system F - German earthing System)
- 2 CEE sockets 16A, 400V, 5p
- 1 CEE socket 32A, 400V, 5p

**Fuse:**

- 2 Neozed D01, 1p
- 2 Neozed D01, 3p

**Cable entry/inlet:**

- CEE inlet 32A, 400V, 5p



Item  
02

Order no. **522590**

**Components:**

- 6 Domestic sockets 16A, 230V ~ (system F - German earthing System)
- 2 CEE sockets 16A, 400V, 5p
- 1 CEE socket 32A, 400V, 5p
- 1 rotary field measuring device

**Fuse:**

- 3 C-type MCBs 16A, 1p
- 1 C-type MCB 16A, 3p
- 1 RCCB 40/0.03A, 4p

**Cable entry/inlet:**

- CEE phase inverter 32A, 400V, 5p



Item  
03

Order no. **5201558**

**Components:**

- 3 Domestic sockets 16A, 230V ~ (system F - German earthing System)
- 2 CEE sockets 16A, 400V, 5p
- 1 CEE socket 32A, 400V, 5p

**Fuse:**

- 3 C-type MCBs 16A, 1p
- 1 C-type MCB 16A, 3p
- 1 RCCB 40/0.03A, 4p

**Cable entry/inlet:**

- CEE inlet 32A, 400V, 5p



Item  
04

Order no. **5201047**

**Components:**

- 4 Domestic sockets 16A, 230V ~ (system F - German earthing System)
- 2 CEE sockets 16A, 400V, 5p
- 1 CEE socket 32A, 400V, 5p

**Fuse:**

- 4 C-type MCBs 16A, 1p
- 2 C-type MCBs 16A, 3p
- 1 RCCB 40/0.03A, 4p

**Cable entry/inlet:**

- CEE inlet 32A, 400V, 5p



Item  
05

Order no. **522144**

**Components:**

- 2 Domestic sockets 16A, 230V ~ (system F - German earthing System)
- 2 CEE sockets 16A, 400V, 5p
- 2 CEE sockets 32A, 400V, 5p

**Fuse:**

- 1 Neozed D01, 1p
- 1 Neozed D01, 3p

**Cable entry/inlet:**

- CEE inlet 32A, 400V, 5p



Item  
06

Order no. **5201015**

**Components:**

- 4 Domestic sockets 16A, 230V ~ (system F - German earthing System)
- 1 CEE socket 16A, 400V, 5p
- 1 CEE socket 32A, 400V, 5p

**Fuse:**

- 2 C-type MCBs 16A, 1p
- 1 C-type MCB 16A, 3p
- 1 RCCB 40/0.03A, 4p

**Cable entry/inlet:**

- CEE plug 32A, 400V, 5p with lead 2 m H07RN-F5G4

# Floor-standing distributors

## Solid-rubber Enclosure, portable

- Ready wired for installation

- Protection degree IP44

- All distributors on this page with domestic sockets, German earthing



Order no. **5201926**

**Components:**

4 Domestic sockets 16A, 230V ~  
(system F - German earthing System)  
1 CEE socket 16A, 400V, 5p  
2 CEE sockets 32A, 400V, 5p

**Fuse:**

2 C-type MCBs 16A, 1p  
1 C-type MCB 16A, 3p  
1 RCCB 40/0.03A, 4p

**Cable entry/inlet:**

CEE plug 32A, 400V, 5p with  
3 m cable H07RN-F5G6

Item  
**01**



Order no. **5202236**

**Components:**

3 Domestic sockets 16A, 230V ~  
(system F - German earthing System)  
2 CEE sockets 16A, 400V, 5p  
2 CEE sockets 32A, 400V, 5p

**Fuse:**

3 C-type MCBs 16A, 1p  
2 C-type MCBs 16A, 3p  
1 RCCB 40/0.03A, 4p

**Cable entry/inlet:**

CEE inlet 32A, 400V, 5p

Item  
**02**



Order no. **5200568**

**Components:**

3 Domestic sockets 16A, 230V ~  
(system F - German earthing System)  
3 CEE sockets 32A, 400V, 5p

**Fuse:**

3 C-type MCBs 16A, 1p  
1 RCCB 40/0.03A, 4p

**Cable entry/inlet:**

CEE inlet 32A, 400V, 5p

Item  
**03**



Order no. **524449**

**Components:**

4 Domestic sockets 16A, 230V ~  
(system F - German earthing System)  
2 CEE sockets 32A, 400V, 5p

**Fuse:**

4 C-type MCBs 16A, 1p

**Cable entry/inlet:**

CEE inlet 32A, 400V, 5p

Item  
**04**



Order no. **5225**

**Components:**

4 Domestic sockets 16A, 230V ~  
(system F - German earthing System)  
2 CEE sockets 16A, 400V, 5p

**Cable entry/inlet:**

CEE inlet 16A, 400V, 5p

Item  
**05**



Order no. **5201004**

**Components:**

3 Domestic sockets 16A, 230V ~  
(system F - German earthing System)  
1 CEE socket 16A, 400V, 5p  
2 CEE sockets 32A, 400V, 5p

**Fuse:**

3 C-type MCBs 16A, 1p  
1 C-type MCB 16A, 3p  
1 RCCB 40/0.03A, 4p

**Cable entry/inlet:**

CEE inlet 32A, 400V, 5p

Item  
**06**



Order no. **5200917**

**Components:**

4 Domestic sockets 16A, 230V ~  
(system F - German earthing System)  
1 CEE socket 16A, 400V, 5p  
1 CEE socket 32A, 400V, 5p

**Fuse:**

2 C-type MCBs 16A, 1p  
1 C-type MCB 16A, 3p  
1 RCCB 40/0.03A, 4p

**Cable entry/inlet:**

CEE inlet 32A, 400V, 5p

Item  
**07**



Order no. **5202237**

**Components:**

3 Domestic sockets 16A, 230V ~  
(system F - German earthing System)  
2 CEE sockets 16A, 400V, 5p  
1 CEE socket 32A, 400V, 5p

**Fuse:**

3 C-type MCBs 16A, 1p  
1 C-type MCB 16A, 3p  
1 RCCB 40/0.03A, 4p

**Cable entry/inlet:**

CEE plug 32A, 400V, 5p with  
lead 3 m H07RN-F5G4

Item  
**08**





# Floor-standing distributors

# Solid-rubber Enclosure, portable

- Ready wired for installation

- Protection degree IP44

- All distributors on this page with domestic sockets, German earthing



Order no. **526**

**Components:**

5 Domestic sockets 16A, 230V ~  
(system F - German earthing System)  
2 CEE sockets 16A, 400V, 5p

**Cable entry/inlet:**

CEE inlet 16A, 400V, 5p

Item  
**01**



Order no. **5202238**

**Components:**

4 Domestic sockets 16A, 230V ~  
(system F - German earthing System)  
1 CEE socket 16A, 400V, 5p  
2 CEE sockets 32A, 400V, 5p

**Fuse:**

4 C-type MCBs 16A, 1p  
1 C-type MCB 16A, 3p  
1 RCCB 40/0.03A, 4p

**Cable entry/inlet:**

CEE inlet 32A, 400V, 5p

Item  
**02**



Order no. **522143**

**Components:**

3 Domestic sockets 16A, 230V ~  
(system F - German earthing System)  
2 CEE sockets 16A, 400V, 5p  
1 CEE socket 32A, 400V, 5p

**Fuse:**

3 Neozed D01, 1p  
1 Neozed D01, 3p  
1 RCCB 40/0.03A, 4p

**Cable entry/inlet:**

CEE inlet 32A, 400V, 5p

Item  
**03**



Order no. **52638**

**Components:**

4 Domestic sockets 16A, 230V ~  
(system F - German earthing System)  
2 CEE sockets 16A, 400V, 5p

**Fuse:**

1 RCCB 40/0.03A, 4p

**Cable entry/inlet:**

CEE plug 16A, 400V, 5p with  
lead 2 m H07RN-F5G2,5

Item  
**04**



Order no. **5201555**

**Components:**

3 Domestic sockets 16A, 230V ~  
(system F - German earthing System)  
1 CEE socket 16A, 400V, 5p  
1 CEE socket 32A, 400V, 5p

**Fuse:**

3 C-type MCBs 16A, 1p  
1 C-type MCB 16A, 3p  
1 RCCB 40/0.03A, 4p

**Cable entry/inlet:**

CEE inlet 32A, 400V, 5p

Item  
**05**



Order no. **52480**

**Components:**

4 Domestic sockets 16A, 230V ~  
(system F - German earthing System)  
2 CEE sockets 16A, 400V, 5p

**Fuse:**

1 RCCB 40/0.03A, 4p

**Cable entry/inlet:**

CEE inlet 16A, 400V, 5p

Item  
**06**



Order no. **522589**

**Components:**

6 Domestic sockets 16A, 230V ~  
(system F - German earthing System)  
2 CEE sockets 16A, 400V, 5p  
1 rotary field measuring device

**Fuse:**

3 C-type MCBs 16A, 1p  
1 RCCB 40/0.03A, 4p

**Cable entry/inlet:**

CEE phase inverter 16A, 400V, 5p

Item  
**07**

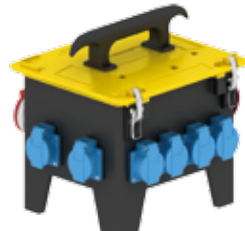

Order no. **523291**

**Components:**

6 Domestic sockets 16A, 230V ~  
(system F - German earthing System)

**Fuse:**

6 C-type MCBs 16A, 1p  
1 RCCB 40/0.03A, 4p

**Cable entry/inlet:**

CEE plug 32A, 400V, 5p with  
lead 3 m H07RN-F5G4

Item  
**08**



# Floor-standing distributors

## Solid-rubber Enclosure, portable

- Ready wired for installation
- Protection degree IP44

- All distributors on this page with domestic sockets, German earthing

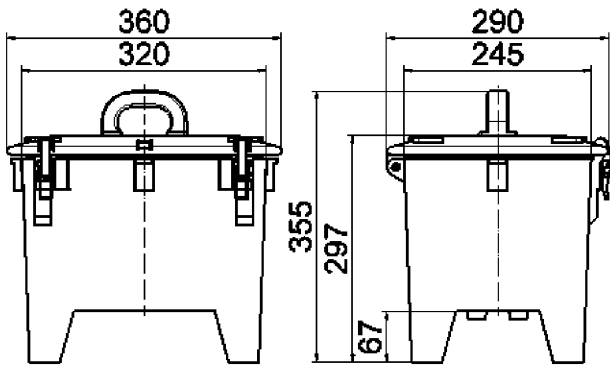

13MB036

- Dimension of enclosure: 320 x 245 mm
- Enclosure made of high-quality, impact-resistant solid rubber
- Ideally suited to tough, harsh and difficult conditions
- Robust solid-rubber handle with hook for cable
- Lockable stainless-steel quick-release fasteners
- Hinged lid, user-friendly access to protective equipment
- Stackable, foot attachment on enclosure cover
- High rubber feet to avoid dirt at floor level



Order no. **5202239**

### Components:

4 Domestic sockets 16A, 230V ~  
(system F - German earthing System)  
2 CEE sockets 16A, 400V, 5p  
2 CEE sockets 32A, 400V, 5p

### Fuse:

4 C-type MCBs 16A, 1p  
2 C-type MCBs 16A, 3p  
2 C-type MCBs 32A, 3p  
1 RCCB 63/0.03A, 4p

### Cable entry/inlet:

CEE plug 63A, 400V, 5p with  
lead 2 m H07RN-F5G10

Item  
01



Order no. **5202240**

### Components:

4 Domestic sockets 16A, 230V ~  
(system F - German earthing System)  
1 CEE socket 16A, 400V, 5p  
1 CEE socket 32A, 400V, 5p  
1 CEE socket 63A, 400V, 5p

### Fuse:

2 C-type MCBs 16A, 1p  
1 C-type MCB 16A, 3p  
1 C-type MCB 32A, 3p  
1 RCCB 63/0.03A, 4p

### Cable entry/inlet:

CEE plug 63A, 400V, 5p with  
lead 3 m H07RN-F5G10

Item  
02



Order no. **524443**

### Components:

4 Domestic sockets 16A, 230V ~  
(system F - German earthing System)  
3 CEE sockets 16A, 400V, 5p  
1 CEE socket 32A, 400V, 5p

### Fuse:

2 Neozed D01, 1p  
3 Neozed D01, 3p

### Cable entry/inlet:

CEE plug 32A, 400V, 5p with  
lead 3 m H07RN-F5G4

Item  
03



Order no. **522167**

### Components:

4 Domestic sockets 16A, 230V ~  
(system F - German earthing System)  
3 CEE sockets 16A, 400V, 5p  
1 CEE socket 32A, 400V, 5p

### Fuse:

2 Neozed D01, 1p  
3 Neozed D01, 3p

### Cable entry/inlet:

CEE inlet 32A, 400V, 5p

Item  
04



Order no. **521828**

### Components:

4 Domestic sockets 16A, 230V ~  
(system F - German earthing System)  
4 CEE sockets 32A, 400V, 5p

### Fuse:

4 Neozed D01, 1p  
1 RCCB 40/0.03A, 4p

### Cable entry/inlet:

CEE inlet 32A, 400V, 5p

Item  
05



Order no. **5202241**

### Components:

4 Domestic sockets 16A, 230V ~  
(system F - German earthing System)  
1 CEE socket 16A, 400V, 5p  
1 CEE socket 32A, 400V, 5p  
1 CEE socket 63A, 400V, 5p

### Fuse:

2 C-type MCBs 16A, 1p  
1 C-type MCB 16A, 3p  
1 C-type MCB 32A, 3p  
1 RCCB 63/0.03A, 4p

### Cable entry/inlet:

CEE inlet 63A, 400V, 5p

Item  
06

# Floor-standing distributors

# Solid-rubber Enclosure, portable

- Ready wired for installation

- Protection degree IP44

- All distributors on this page with domestic sockets, German earthing



Order no. **524446**

**Components:**  
 4 Domestic sockets 16A, 230V ~  
 (system F - German earthing System)  
 1 CEE socket 16A, 400V, 5p  
 1 CEE socket 32A, 400V, 5p  
 1 CEE socket 63A, 400V, 5p

**Fuse:**  
 2 Neozed D01, 1p  
 1 Neozed D01, 3p  
 1 Neozed D02, 3p  
 1 RCCB 63/0.03A, 4p

**Cable entry/inlet:**  
 CEE plug 63A, 400V, 5p with  
 lead 3 m H07RN-F5G10

Item  
**01**



Order no. **5202242**

**Components:**  
 6 Domestic sockets 16A, 230V ~  
 (system F - German earthing System)  
 1 CEE socket 16A, 400V, 5p  
 1 CEE socket 32A, 400V, 5p  
 1 CEE socket 63A, 400V, 5p

**Fuse:**  
 6 C-type MCBs 16A, 1p  
 1 C-type MCB 16A, 3p  
 1 C-type MCB 32A, 3p  
 1 RCCB 63/0.03A, 4p

**Cable entry/inlet:**  
 CEE plug 63A, 400V, 5p with  
 lead 2 m H07RN-F5G16

Item  
**02**



Order no. **5202469**

**Components:**  
 6 Domestic sockets 16A, 230V ~  
 (system F - German earthing System)  
 1 CEE socket 16A, 400V, 5p  
 1 CEE socket 32A, 400V, 5p  
 1 CEE socket 63A, 400V, 5p

**Fuse:**  
 6 C-type MCBs 16A, 1p  
 1 C-type MCB 16A, 3p  
 1 C-type MCB 32A, 3p  
 1 RCCB 63/0.03A, 4p

**Cable entry/inlet:**  
 CEE inlet 63A, 400V, 5p

Item  
**03**



Order no. **5202243**

**Components:**  
 8 Domestic sockets 16A, 230V ~  
 (system F - German earthing System)  
 1 CEE socket 16A, 400V, 5p  
 1 CEE socket 32A, 400V, 5p

**Fuse:**  
 4 C-type MCBs 16A, 1p  
 1 C-type MCB 16A, 3p  
 1 RCCB 40/0.03A, 4p

**Cable entry/inlet:**  
 CEE plug 32A, 400V, 5p with  
 lead 3 m H07RN-F5G4

Item  
**04**



Order no. **5202244**

**Components:**  
 8 Domestic sockets 16A, 230V ~  
 (system F - German earthing System)  
 1 CEE socket 16A, 400V, 5p  
 1 CEE socket 32A, 400V, 5p

**Fuse:**  
 4 C-type MCBs 16A, 1p  
 1 C-type MCB 16A, 3p  
 1 RCCB 40/0.03A, 4p

**Cable entry/inlet:**  
 CEE inlet 32A, 400V, 5p

Item  
**05**



Order no. **5201003**

**Components:**  
 3 Domestic sockets 16A, 230V ~  
 (system F - German earthing System)  
 1 CEE socket 16A, 400V, 5p  
 2 CEE sockets 32A, 400V, 5p  
 1 CEE socket 63A, 400V, 5p

**Fuse:**  
 3 C-type MCBs 16A, 1p  
 1 C-type MCB 16A, 3p  
 2 C-type MCBs 32A, 3p  
 1 RCCB 63/0.03A, 4p

**Cable entry/inlet:**  
 CEE inlet 63A, 400V, 5p

Item  
**06**



Order no. **5202245**

**Components:**  
 4 Domestic sockets 16A, 230V ~  
 (system F - German earthing System)  
 2 CEE sockets 16A, 400V, 5p  
 2 CEE sockets 32A, 400V, 5p

**Fuse:**  
 2 C-type MCBs 16A, 1p  
 2 C-type MCBs 16A, 3p  
 2 C-type MCBs 32A, 3p  
 1 RCCB 63/0.03A, 4p

**Cable entry/inlet:**  
 CEE plug 63A, 400V, 5p with  
 lead 3 m H07RN-F5G10

Item  
**07**

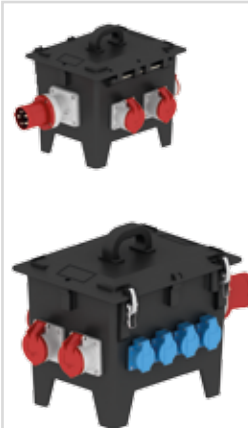

Order no. **5202470**

**Components:**  
 4 Domestic sockets 16A, 230V ~  
 (system F - German earthing System)  
 2 CEE sockets 16A, 400V, 5p  
 2 CEE sockets 32A, 400V, 5p

**Fuse:**  
 2 C-type MCBs 16A, 1p  
 2 C-type MCBs 16A, 3p  
 2 C-type MCBs 32A, 3p  
 1 RCCB 63/0.03A, 4p

**Cable entry/inlet:**  
 CEE inlet 63A, 400V, 5p

Item  
**08**

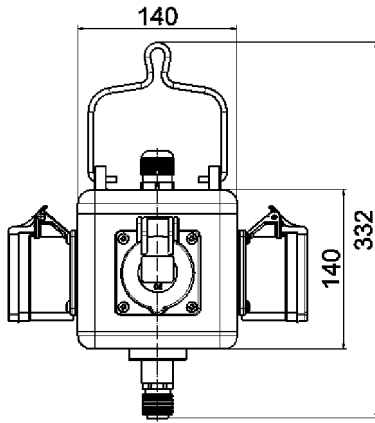

13MB045

- Dimension of enclosure: 140 x 140 mm
- Enclosure made of high-quality, impact-resistant solid rubber
- Small, compact design
- Variable configuration
- Fuse protection and data systems safely protected behind an operating window
- Top and bottom in signal yellow
- Hanging bracket made of V2A stainless steel
- Easy connection and disconnection of loads by means of knob or grip hook
- Unproblematic connection of supply cable by means of specially developed clamping ring

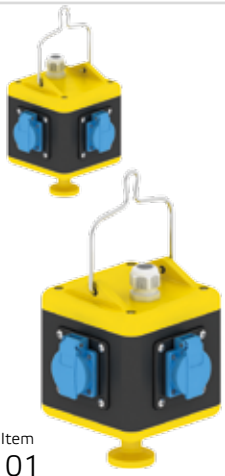

Item  
01

Order no. **57092**

**Components:**  
4 Domestic sockets 16A, 230V ~  
(system F - German earthing System)

**Cable entry:**  
1x M25

**Connection option:**  
for 1 cable up to 5 x 10 mm<sup>2</sup>

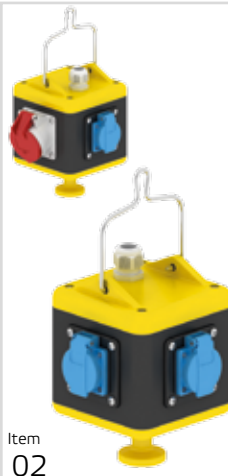

Item  
02

Order no. **57076**

**Components:**  
3 Domestic sockets 16A, 230V ~  
(system F - German earthing System)  
1 CEE socket 16A, 400V, 5p

**Cable entry:**  
1x M25

**Connection option:**  
for 1 cable up to 5 x 10 mm<sup>2</sup>



Item  
03

Order no. **57078**

**Components:**  
2 Domestic sockets 16A, 230V ~  
(system F - German earthing System)  
2 CEE sockets 16A, 400V, 5p

**Cable entry:**  
1x M25

**Connection option:**  
for 1 cable up to 5 x 10 mm<sup>2</sup>



Item  
04

Order no. **57117**

**Components:**  
2 Domestic sockets 16A, 230V ~  
(system F - German earthing System)  
2 CEE sockets 16A, 400V, 5p  
1 compressed air connection:  
(inlet: 1/2" pipe with external thread;  
outlet: 1/2" quick-release connector)

**Cable entry:**  
1x M25

**Connection option:**  
for 1 cable up to 5 x 10 mm<sup>2</sup>

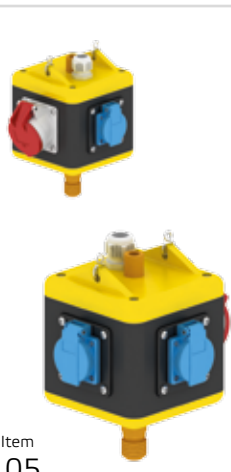

Item  
05

Order no. **57116**

**Components:**  
3 Domestic sockets 16A, 230V ~  
(system F - German earthing System)  
1 CEE socket 16A, 400V, 5p  
1 compressed air connection:  
(inlet: 1/2" pipe with external thread;  
outlet: 1/2" quick-release connector)

**Cable entry:**  
1x M25

**Connection option:**  
for 1 cable up to 5 x 10 mm<sup>2</sup>

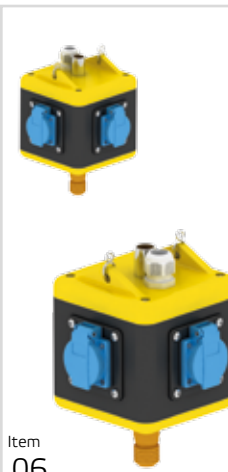

Item  
06

Order no. **57119**

**Components:**  
4 Domestic sockets 16A, 230V ~  
(system F - German earthing System)  
1 compressed air connection  
(inlet: 1/2" pipe with external thread;  
outlet: 1/2" quick-release connector)

**Cable entry:**  
1x M25

**Connection option:**  
for 1 cable up to 5 x 10 mm<sup>2</sup>

(inlet: 1/2" hose connector NW 13 mm  
output: 1/2" two-way quick-release  
connector)

## Solid-rubber Enclosure, Suspended Distributors

# Uni-Block

**Cable entry:** - Ready wired for installation  
2x M25 (2 circuits) - Protection degree IP44  
- All distributors on this page with domestic sockets, German earthing

**Connection option:**  
for 2 cables up to 5 x 10 mm<sup>2</sup>



Order no. **571121**

**Components:**  
3 Domestic sockets 16A, 230V ~  
(system F - German earthing System)  
1 CEE socket 16A, 400V, 5p  
1 compressed air connection  
(inlet: 1/2" hose connector NW 13 mm  
output: 1/2" two-way quick-release  
connector)

**Cable entry:**  
2x M25 (2 circuits)

**Connection option:**  
for 2 cables up to 5 x 10 mm<sup>2</sup>



Order no. **573395**

**Components:**  
3 Domestic sockets 16A, 230V ~  
(system F - German earthing System)  
4 data sockets RJ45/ Cat. 6

**Cable entry:**  
1x M25, 1x M32

**Connection option:**  
for 1 cable up to 5 x 10 mm<sup>2</sup>



Order no. **57829**

**Components:**  
2 Domestic sockets 16A, 230V ~  
(system F - German earthing System)  
1 CEE socket 16A, 400V, 5p

**Fuse:**  
1 RCCB 40/0.03A, 4p

**Cable entry:**  
1x M25

**Connection option:**  
for 1 cable up to 5 x 10 mm<sup>2</sup>



Order no. **57250**

**Components:**  
2 Domestic sockets 16A, 230V ~  
(system F - German earthing System)  
1 CEE socket 16A, 400V, 5p  
1 CEE socket 32A, 400V, 5p

**Cable entry:**  
1x M25, 1x M32 (2 circuits)

**Connection option:**  
for 2 cables up to 5 x 10 mm<sup>2</sup>

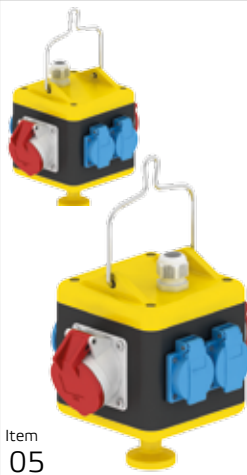

Order no. **57986**

**Components:**  
4 Domestic sockets 16A, 230V ~  
(system F - German earthing System)  
2 CEE sockets 16A, 400V, 5p

**Cable entry:**  
1x M25

**Connection option:**  
for 1 cable up to 5 x 10 mm<sup>2</sup>



Order no. **57074**

**Components:**  
4 CEE sockets 16A, 400V, 5p

**Cable entry:**  
1x M25

**Connection option:**  
for 1 cable up to 5 x 10 mm<sup>2</sup>



Order no. **571276**

**Components:**  
3 Domestic sockets 16A, 230V ~  
(system F - German earthing System)

**Fuse:**  
1 RCCB 40/0.03A, 4p

**Cable entry:**  
1x M25

**Connection option:**  
for 1 cable up to 5 x 10 mm<sup>2</sup>



Order no. **570531**

**Components:**  
2 Domestic sockets 16A, 230V ~  
(system F - German earthing System)  
1 CEE socket 16A, 400V, 5p  
1 empty space for data sockets

**Cable entry:**  
2x M25

**Connection option:**  
for 1 cable up to 5 x 10 mm<sup>2</sup>

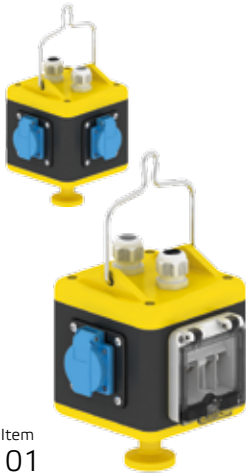

Item 01

Order no. **573143**

**Components:**  
3 Domestic sockets 16A, 230V ~  
(system F - German earthing System)  
2 data sockets RJ45/ Cat. 6

**Cable entry:**  
2x M25

**Connection option:**  
for 1 cable up to 5 x 10 mm<sup>2</sup>



Item 02

Order no. **572231**

**Components:**  
2 Domestic sockets 16A, 230V ~  
(system F - German earthing System)  
2 CEE sockets 16A, 400V, 5p

**Fuse:**  
1 RCCB 40/0.03A, 4p

**Cable entry:**  
1x M25

**Connection option:**  
for 1 cable up to 5 x 10 mm<sup>2</sup>



Item 03

Order no. **57963**

**Components:**  
3 Domestic sockets 16A, 230V ~  
(system F - German earthing System)

**Fuse:**  
1 RCCB 25/0.03A, 2p

**Cable entry:**  
1x M25

**Connection option:**  
for 1 cable up to 3 x 10 mm<sup>2</sup>



Item 04

Order no. **570451**

**Components:**  
4 Domestic sockets 16A, 230V ~  
(system F - German earthing System)

**Fuse:**  
1 RCCB 40/0.03A, 4p

**Cable entry:**  
1x M20

**Connection option:**  
for 1 cable up to 5 x 10 mm<sup>2</sup>

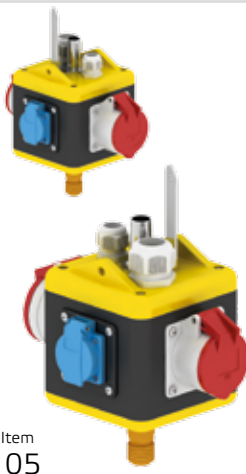

Item 05

Order no. **57711**

**Components:**  
2 Domestic sockets 16A, 230V ~  
(system F - German earthing System)  
1 CEE socket 16A, 400V, 5p  
1 CEE socket 32A, 400V, 5p  
1 compressed air connection:  
(inlet: 1/2" pipe with external thread;  
outlet: 1/2" quick-release connector)

**Cable entry:**  
1x M25, 1x M32 (2 circuits)

**Connection option:**  
for 2 cables up to 5 x 10 mm<sup>2</sup>



Item 06

Order no. **573151**

**Components:**  
6 Domestic sockets 16A, 230V ~  
(system F - German earthing System)  
2 data sockets RJ45/ Cat. 6

**Cable entry:**  
2x M25

**Connection option:**  
for 1 cable up to 5 x 10 mm<sup>2</sup>

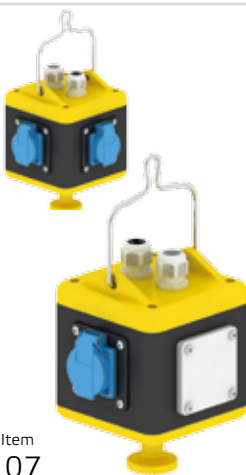

Item 07

Order no. **57360**

**Components:**  
3 Domestic sockets 16A, 230V ~  
(system F - German earthing System)  
1 empty space for data sockets

**Cable entry:**  
2x M25

**Connection option:**  
for 1 cable up to 5 x 10 mm<sup>2</sup>

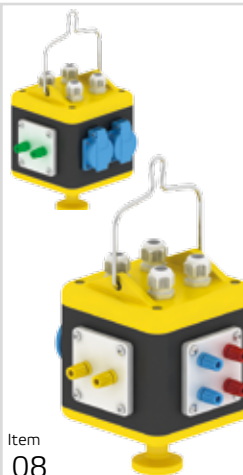

Item 08

Order no. **571370**

**Components:**  
2 Domestic sockets 16A, 230V ~  
(system F - german earthing System)  
with child protection  
2 laboratory sockets yellow/green, earth  
potential  
Laboratory sockets 2x blue and 2x red  
DC extra-low voltage  
2 laboratory sockets yellow, AC  
extra-low voltage

**Cable entry:**  
4x M20

**Connection option:**  
for 1 cable up to 3 x 10 mm<sup>2</sup>

**Cable gland**



- Black
- Protection degree IP67

	Thread	Sealing range	Order no.
	M12	3-6 mm	<b>580647</b>
	M20	8-13 mm	<b>580648</b>
	M25	11-17 mm	<b>580649</b>
	M32	15-21 mm	<b>580650</b>
	M40	19-28 mm	<b>580651</b>
Multiple sealing insert	for M25	2x8 mm	<b>580652</b>
	for M32	4x8 mm	<b>580653</b>

**Cable gland with pressure equalisation**

The use of pressure equalisation cable glands allows the internal pressure to adjust to the ambient pressure. The type-tested protection degree of the enclosure is fully retained. Temperature fluctuations, intense sunlight, or a sudden change in weather can cause condensation to form in combination enclosures. Basically, condensation can form in all sealed solid-rubber distributors. The higher the protection degree is, the more likely the formation of condensation will be.

We therefore recommend, especially in the case of distributors with protection degree IP67, the use of pressure equalisation cable glands.



- Minimised condensation formation and therefore reduction in downtimes and time-consuming and expensive repair work
- No expensive and high-maintenance ventilation technology required
- No drip holes which reduce the level of protection
- With air ducts for pressure equalisation
- black
- Protection degree IP67

	Thread	Sealing range	Order no.
	M20	6-13 mm	<b>580656</b>
	M25	9-17 mm	<b>580657</b>
	M32	13-21 mm	<b>580658</b>
	M40	16-28 mm	<b>580659</b>

**Mounting set**



- For MODBOX and MODBOX-Midi
- Consisting of:  
4 screws 6 x 60 mm  
4 screw anchors 8 x 51 mm

Order no. **580640**

**Lock set**



- For MODBOX operating window
  - With locking cylinder and 2 keys
- Order no. **58037-BE**



- For MODBOX-Midi OTC window
- With long shackle and 2 keys

Order no. **580642**

**Portable stand**



- For MODBOX and MODBOXMidi
- Hot-dip galvanised steel tubing
- Folding
- Weight 4 kg
- Dimensions: 350/570 x 780 x 540 mm

(W x H x D)

Order no. **580721**

**Power-Port floor-standing distributor without door**



- Only for MODBOX-Midi
- Enclosure dimensions 1300 x 350 x 275 mm (H x W x D)
- Enclosure made of high-quality V2A stainless steel
- Ground metal surface
- Moveable panel for concealing cables
- Base plate suitable for pedestal mounting
- Available in different colours (optional)

Order no. **580589**

**Power-Port floor-standing distributor with door**



- Only for MODBOX-Midi
- Enclosure dimensions 1300 x 350 x 415 mm (H x W x D)
- Enclosure made of high-quality V2A stainless steel
- Ground metal surface
- Moveable panel for concealing cables
- Base plate suitable for pedestal mounting
- Door with box lock and single profile cylinder, internal hinges
- Brush seal prevents dirt and dust from entering when door is closed
- Outgoing cables can be guided out through brush-sealed opening on front side
- Available in different colours (optional)

Order no. **580508**



 **Bals**  
Simply. Well. Connected.

Bals Elektrotechnik GmbH & Co. KG  
D-57399 Kirchhudem-Albaum  
Telefon: +49 27 23/771-0  
Fax: +4927 23/771-177/178  
E-mail: [info@bals.com](mailto:info@bals.com)  
Internet: [www.bals.com](http://www.bals.com)